

# User Manual

**Tektronix**

**TDS 210 & TDS 220**  
**Digital Real-Time Oscilloscopes**  
**070-8483-05**

This document supports firmware version  
FV:v1.00 and above.



Copyright © Tektronix, Inc. All rights reserved.

Tektronix products are covered by U.S. and foreign patents, issued and pending. Information in this publication supercedes that in all previously published material. Specifications and price change privileges reserved.

Printed in the U.S.A.

Tektronix, Inc., P.O. Box 1000, Wilsonville, OR 97070-1000

TEKTRONIX and TEK are registered trademarks of Tektronix, Inc.

**WARRANTY SUMMARY**  
**(TDS 210 and TDS 220 Digitizing Oscilloscopes)**

Tektronix warrants that the products that it manufactures and sells will be free from defects in materials and workmanship for a period of three (3) years from the date of shipment from an authorized Tektronix distributor. If a product or CRT proves defective within the respective period, Tektronix will provide repair or replacement as described in the complete warranty statement.

To arrange for service or obtain a copy of the complete warranty statement, please contact your nearest Tektronix sales and service office.

EXCEPT AS PROVIDED IN THIS SUMMARY OR THE APPLICABLE WARRANTY STATEMENT, TEKTRONIX MAKES NO WARRANTY OF ANY KIND, EXPRESS OR IMPLIED, INCLUDING WITHOUT LIMITATION THE IMPLIED WARRANTIES OF MERCHANTABILITY AND FITNESS FOR A PARTICULAR PURPOSE. IN NO EVENT SHALL TEKTRONIX BE LIABLE FOR INDIRECT, SPECIAL OR CONSEQUENTIAL DAMAGES.

**WARRANTY SUMMARY  
(P6112 Probe)**

Tektronix warrants that the products that it manufactures and sells will be free from defects in materials and workmanship for a period of one (1) year from the date of shipment. If a product proves defective within the respective period, Tektronix will provide repair or replacement as described in the complete warranty statement.

To arrange for service or obtain a copy of the complete warranty statement, please contact your nearest Tektronix sales and service office.

**EXCEPT AS PROVIDED IN THIS SUMMARY OR THE APPLICABLE WARRANTY STATEMENT, TEKTRONIX MAKES NO WARRANTY OF ANY KIND, EXPRESS OR IMPLIED, INCLUDING WITHOUT LIMITATION THE IMPLIED WARRANTIES OF MERCHANTABILITY AND FITNESS FOR A PARTICULAR PURPOSE. IN NO EVENT SHALL TEKTRONIX BE LIABLE FOR INDIRECT, SPECIAL OR CONSEQUENTIAL DAMAGES.**

## Service Assurance

If you have not already purchased Service Assurance for this product, you may do so at any time during the product's warranty period. Service Assurance provides Repair Protection and Calibration Services to meet your needs.

**Repair Protection** extends priority repair services beyond the product's warranty period; you may purchase up to three years of Repair Protection.

**Calibration Services** provide annual calibration of your product, standards compliance and required audit documentation, recall assurance, and reminder notification of scheduled calibration. Coverage begins upon registration; you may purchase up to five years of Calibration Services.

### Service Assurance Advantages

- Priced well below the cost of a single repair or calibration
- Avoid delays for service by eliminating the need for separate purchase authorizations from your company
- Eliminates unexpected service expenses

### For Information and Ordering

For more information or to order Service Assurance, contact your Tektronix representative and provide the information below. Service Assurance may not be available in locations outside the United States of America.

Name	VISA or Master Card number and expiration
Company	date or purchase order number
Address	Repair Protection (1,2, or 3 years)
City, State, Postal code	Calibration Services (1,2,3,4, or 5 years)
Country	Instrument model and serial number
Phone	Instrument purchase date





# Table of Contents

<b>General Safety Summary</b> .....	<b>iii</b>
<b>Getting Started</b> .....	<b>1</b>
General Features .....	2
Installation .....	3
Power Cord .....	3
Security Loop .....	3
Extension Modules .....	4
Functional Check .....	5
Probe Compensation .....	6
Self Calibration .....	7
Probe Safety .....	7
Probe Attenuation Setting .....	8
<b>Operating Basics</b> .....	<b>9</b>
Display Area .....	10
Waveform Displays .....	12
Vertical Controls .....	14
Horizontal Controls .....	15
Trigger Controls .....	16
Control Buttons .....	17
Connectors .....	18
<b>Reference</b> .....	<b>19</b>
Acquire .....	20
Autoset .....	24
Cursors .....	25
Display .....	26
Hard Copy .....	28
Horizontal .....	29
Math .....	31
Measure .....	32
Save/Recall .....	34
Triggering .....	36
Utility .....	40
Vertical .....	42

Table of Contents

---

**Appendix A: Specifications . . . . . 44**  
**Appendix B: Accessories . . . . . 54**  
**Appendix C: General Care and Cleaning . . . . . 57**  
**Glossary . . . . . 58**  
**Index . . . . . 63**





# General Safety Summary

Review the following safety precautions to avoid injury and prevent damage to this product or any products connected to it. To avoid potential hazards, use this product only as specified.

*Only qualified personnel should perform service procedures.*

## To Avoid Fire or Personal Injury

**Use Proper Power Cord.** Use only the power cord specified for this product and certified for the country of use.

**Connect and Disconnect Properly.** Do not connect or disconnect probes or test leads while they are connected to a voltage source.

**Ground the Product.** This product is grounded through the grounding conductor of the power cord. To avoid electric shock, the grounding conductor must be connected to earth ground. Before making connections to the input or output terminals of the product, ensure that the product is properly grounded.

**Connect the Probe Properly.** The probe ground lead is at ground potential. Do not connect the ground lead to an elevated voltage.

**Observe All Terminal Ratings.** To avoid fire or shock hazard, observe all ratings and marking on the product. Consult the product manual for further ratings information before making connections to the product.

**Do Not Operate Without Covers.** Do not operate this product with covers or panels removed.

**Use Proper Fuse.** Use only the fuse type and rating specified for this product.

**Avoid Exposed Circuitry.** Do not touch exposed connections and components when power is present.

**Do Not Operate With Suspected Failures.** If you suspect there is damage to this product, have it inspected by qualified service personnel.

**Provide Proper Ventilation.** Refer to the manual's installation instructions for details on installing the product so it has proper ventilation.

**Do Not Operate in Wet/Damp Conditions.**

**Do Not Operate in an Explosive Atmosphere.**

**Keep Product Surfaces Clean and Dry.**

## Safety Terms and Symbols

**Terms in This Manual.** These terms may appear in this manual:



---

**WARNING.** *Warning statements identify conditions or practices that could result in injury or loss of life.*

---



---

**CAUTION.** *Caution statements identify conditions or practices that could result in damage to this product or other property.*

---

**Terms on the Product.** These terms may appear on the product:

**DANGER** indicates an injury hazard immediately accessible as you read the marking.

**WARNING** indicates an injury hazard not immediately accessible as you read the marking.

**CAUTION** indicates a hazard to property including the product.

**Symbols on the Product.** These symbols may appear on the product:



**WARNING**  
High Voltage



Protective Ground  
(Earth) Terminal



**CAUTION**  
Refer to Manual



Double  
Insulated



# Getting Started

The TDS 210 and TDS 220 Digitizing Oscilloscopes are two-channel oscilloscopes in a small, lightweight, benchtop package that you can use to take ground-referenced measurements.

In addition to the list of general features, this section covers the following topics:

- How to install your product
- How to add extended functions
- How to perform a brief functional check
- How to compensate probes
- How to use the self calibration routine
- How to match your probe attenuation factor

## General Features

- 100 MHz (TDS 220) or 60 MHz (TDS 210) bandwidth with selectable 20 MHz bandwidth limit
- 1 GS/s sample rate and 2,500 point record length for each channel
- Cursors with readout and five automated measurements
- High-resolution, high-contrast LCD display with temperature compensation and replaceable backlight
- Setup and waveform storage
- Autoset for quick setup
- Waveform averaging and peak detection
- Digital real-time oscilloscope
- Dual time base
- Video trigger capability
- RS-232, GPIB, and Centronics communication ports easily added with optional extension modules
- Variable persistence display
- User interface available in 10 user selectable languages

## Installation

### Power Cord

Use only power cords designed for your oscilloscope. Use a power source that delivers 90 to 250 VAC<sub>RMS</sub>, 45 to 440 Hz. Refer to page 56 for a list of available power cords.

Use the power cord notch to help route the cord to the rear of the instrument and avoid inadvertently disconnecting the power source.

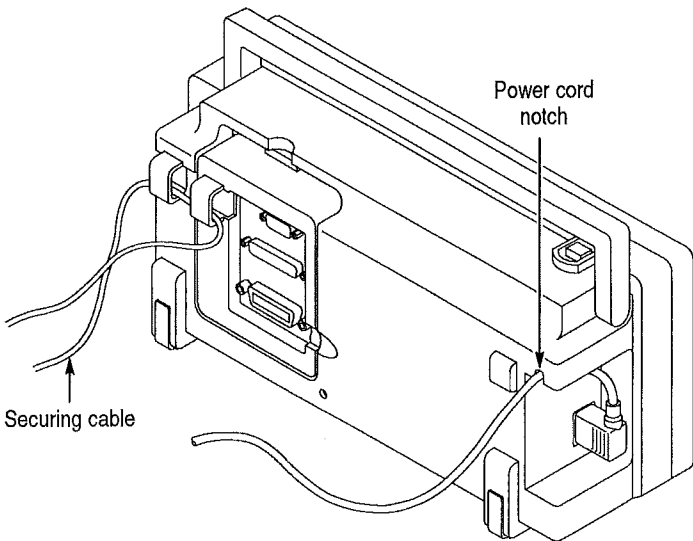

### Security Loop

Use the built-in cable channels to secure both your instrument and extension module to your location.

## Extension Modules

You can increase the feature set of your oscilloscope by inserting an extension module. Refer to page 54 for information about the available modules.



---

**CAUTION.** *Electrostatic discharge (ESD) can damage components in the extension module and the oscilloscope. Do not operate you instrument with the extension module connector exposed.*

---

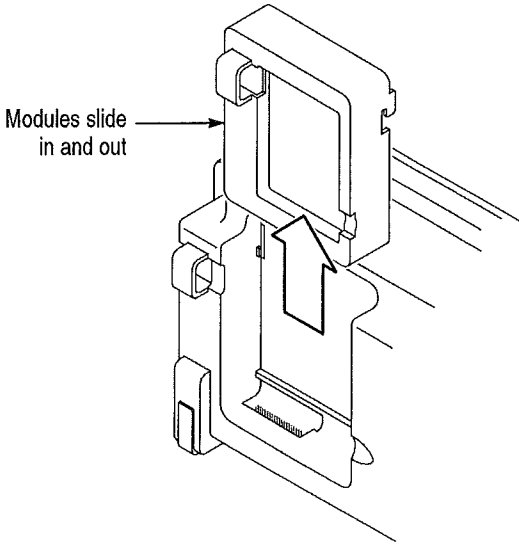

## Functional Check

Perform this quick functional check to verify that your instrument is operating correctly.

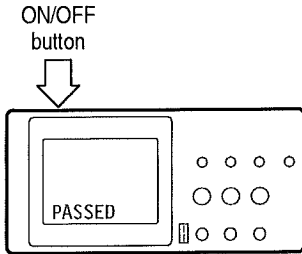

1. Turn on the instrument.

Wait for the confirmation that all self tests have passed.

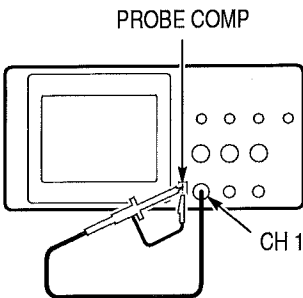

2. Connect the oscilloscope probe to channel 1. Attach the probe tip and reference lead to the PROBE COMP connectors.

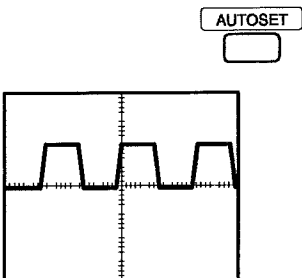

3. Push the AUTOSSET button. Within a few seconds, you should see a squarewave in the display (approximately 5 V at 1 kHz).

Repeat steps 2 and 3 for channel 2.

## Probe Compensation

Perform this adjustment to match your probe to the input channel. This should be done whenever you attach a probe for the first time to any input channel.

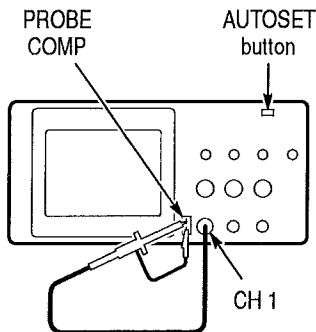

1. Connect the oscilloscope probe to channel 1. Attach the probe tip and reference lead to the PROBE COMP connectors and then press AUTOSET.

If using the probe hook-tip, ensure a proper connection by firmly twisting the tip onto the probe.

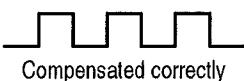

2. Check the shape of the displayed waveform.

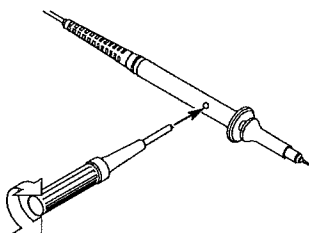

3. If necessary, adjust your probe.

Repeat as necessary.



## Self Calibration

The self calibration routine lets you quickly optimize the oscilloscope signal path for maximum measurement accuracy. You can run the routine at anytime but you should always run the routine if the ambient temperature changes by 5° C or more.

To compensate the signal path, disconnect any probes or cables from the channel 1 and channel 2 input connectors. Then, press the UTILITY button and select Do Self Cal to confirm that you are ready to proceed.

## Probe Safety

A guard around the probe body provides a finger barrier for protection from electric shock.

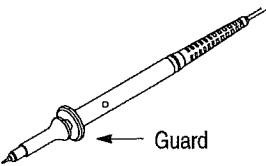

**WARNING.** To avoid electric shock when using the probe, keep fingers behind the guard on the probe body.

To avoid electric shock while using the probe, do not touch metallic portions of the probe head while it is connected to a voltage source.

Connect the probe to the instrument and connect the ground terminal to ground before you take any measurements.

## Probe Attenuation Setting

Probes are available with various attenuation factors which affect the vertical scale readout of the oscilloscope.

To change (or check) the probe attenuation setting, press the VERTICAL MENU button (of the channel you're using) and then press the menu selection next to Probe until the correct setting is displayed.

This setting remains in effect until changed again.

# Operating Basics

The front panel is divided into easy to use, easy to find functional areas.

This section provides you with a quick overview of the controls and the information displayed on the screen.

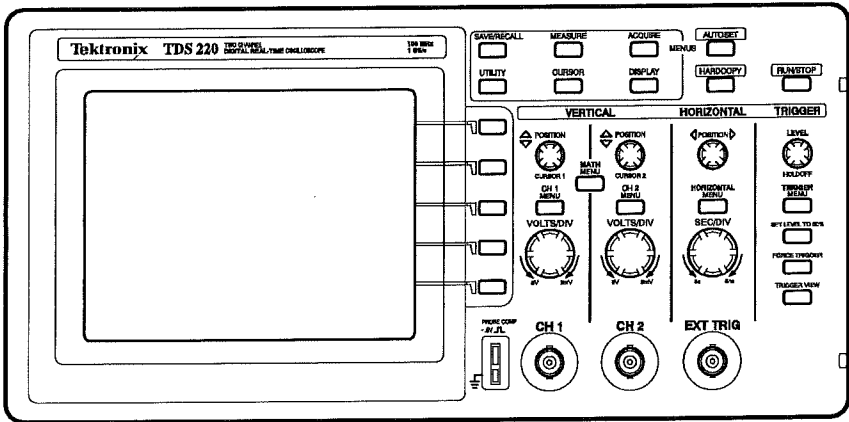

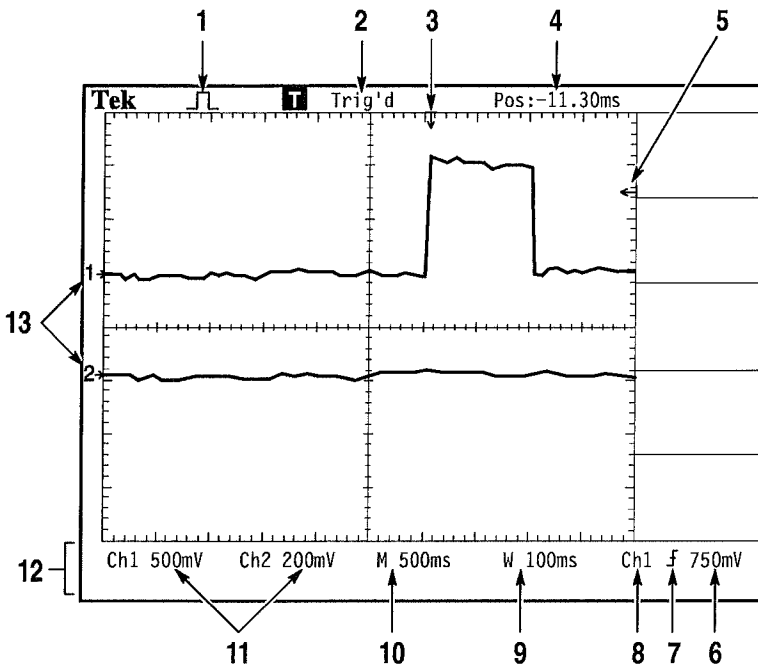

## Display Area

In addition to displaying waveforms, the display is filled with many details about the waveform and the instrument control settings.



1. Icon display shows acquisition mode.

-  Sample mode
-  Peak detect mode
-  Average mode

2. Trigger status shows if there is an adequate trigger source or if the acquisition is stopped.
3. Marker shows horizontal trigger position. This also indicates the horizontal position since the Horizontal Position control actually moves the trigger position horizontally.
4. Trigger position display shows the difference (in time) between the center graticule and the trigger position. Center screen equals zero.
5. Marker shows trigger level.
6. Readout shows numeric value of the trigger level.
7. Icon shows selected trigger slope for edge triggering.
8. Readout shows trigger source used for triggering.
9. Readout shows window zone timebase setting.
10. Readout shows main timebase setting.
11. Readout shows channels 1 and 2 vertical scale factors.
12. Display area shows on-line messages momentarily.
13. On-screen markers show the ground reference points of the displayed waveforms. No marker indicates the channel is not displayed.

## Waveform Displays

Obtaining a waveform display is dependent on many instrument settings. Once you obtain a waveform, you can take your measurements. But the appearance of these waveforms also provides key information about the waveform.

Depending on the type, waveforms will be displayed in three different styles: black, gray, and broken.

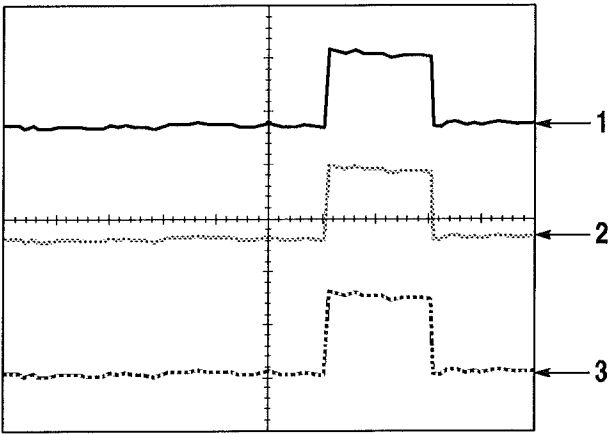

1. A solid black waveform indicates a live waveform display. The waveform remains black when the acquisition is stopped if no controls are changed that makes the display accuracy uncertain. Changing the vertical and horizontal controls is allowed on stopped acquisitions.
2. Reference waveforms and waveforms with persistence applied appear gray.
3. A broken line appearance indicates the waveform display accuracy is uncertain. This is the result of stopping the acquisition and then changing a control setting that the instrument cannot modify the displayed waveform to match. For example, changing the trigger controls on a stopped acquisition causes a broken-line waveform.

## Vertical Controls

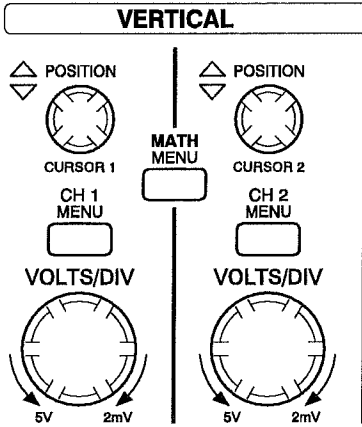

**CH 1 and CURSOR 1 POSITION.** Vertically adjusts the channel 1 display or positions cursor 1.

**CH 2 and CURSOR 2 POSITION.** Vertically adjusts the channel 2 display or positions cursor 2.

**MATH MENU.** Displays waveform math operations menu.

**CH 1 and CH 2 MENU.** Displays the channel input menu selections and toggles the channel display on and off.

**VOLTS/DIV (CH1 and CH 2).** Selects calibrated scale factors.



## Horizontal Controls

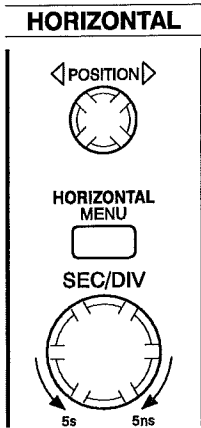

**POSITION.** Adjusts the horizontal position of all channels.

**HORIZONTAL MENU.** Displays the horizontal menu.

**SEC/DIV.** Selects the horizontal time/div (scale factor) for the main timebase and the Window Zone. Refer to page 29 about creating and using the Window Zone.

## Trigger Controls

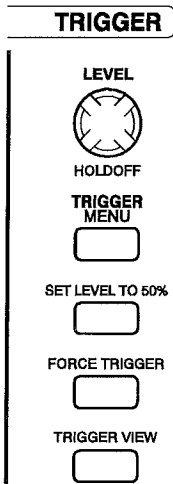

**LEVEL and HOLDOFF.** This control has a dual purpose which is defined in the Horizontal Menu system. As a trigger level control, it sets the amplitude level the signal must cross to cause an acquisition. As a holdoff control, it sets the amount of time before another trigger event can be accepted. Refer to page 29.

**TRIGGER MENU.** Displays the trigger menu.

**SET LEVEL TO 50%.** The trigger level is set to 50% of the signal level.

**FORCE TRIGGER.** Starts an acquisition regardless of an adequate trigger signal.

**TRIGGER VIEW.** Displays the trigger waveform in place of the channel waveform while the TRIGGER VIEW button is held down.

## Control Buttons

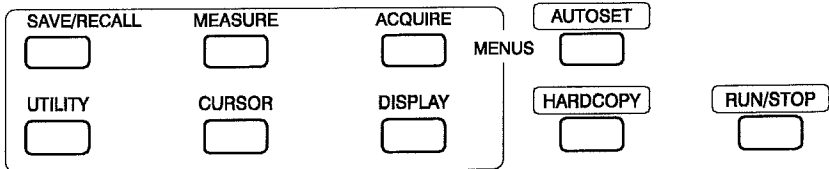

**SAVE/RECALL.** Displays the save/recall menu for setups and waveforms.

**MEASURE.** Displays the automated measurements menu.

**ACQUIRE.** Displays the acquisition menu.

**DISPLAY.** Displays the display type menu.

**CURSOR.** Displays the cursor menu. Vertical Position controls adjust cursor position while displaying the cursor menu. Cursors remain displayed (unless turned off) after leaving the cursor menu but are not adjustable.

**UTILITY.** Displays the utility menus.

**AUTOSET.** Automatically sets the instrument controls to produce a usable display of the input signal.

**HARDCOPY.** Starts print operations. An extension module with a Centronics, RS-232, or GPIB port is required. Refer to *Optional Accessories* on page 54.

**RUN/STOP.** Starts and stops waveform acquisition.

## Connectors

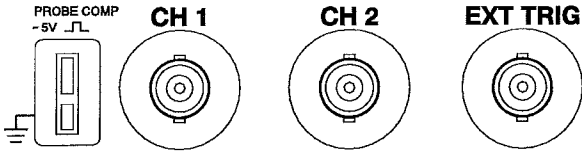

**PROBE COMP.** Voltage probe compensation output and ground. Use this to electrically match the probe to the input circuit. Refer to page 6.

The probe compensation ground and BNC shields are connected to earth ground. Do not connect a voltage source to these ground terminals.

**CH 1 and CH 2.** Input connectors for waveform display.

**EXT TRIG.** Input connector for an external trigger source. Use the trigger menu to select the trigger source.



# Reference

This section describes the menus and operating details associated with each front-panel menu button.

Reference Topic	Page
Acquire	20
Autorange	24
Cursor	25
Display	26
Hard copy	28
Horizontal controls	29
Math	31
Measure	32
Save/Recall	34
Trigger controls	36
Utility	40
Vertical controls	42

## Acquire

Push the ACQUIRE button to set acquisition parameters.

Menus	Settings	Comments
Sample		This is the default mode and provides the fastest acquisition
Peak Detect		Use to detect glitches and reduce the possibility of aliasing
Average		Use to reduce random or uncorrelated noise in the signal display. The number of averages is selectable.
Averages	4 16 64 128	Select Number of Averages

### Key Points

If you probe a noisy square wave signal that contains intermittent, narrow glitches, the waveform displayed will vary depending on the acquisition mode you choose.

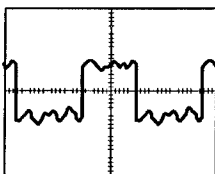

Sample

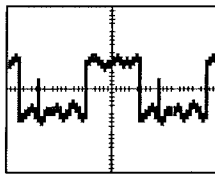

Peak Detect

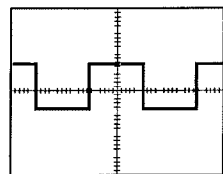

Average

The next two pages describe each of the types of acquisition modes and their differences.

**Sample.** Use Sample acquisition mode to acquire 2,500 points and display them at the SEC/DIV setting. Sample mode is the default mode.

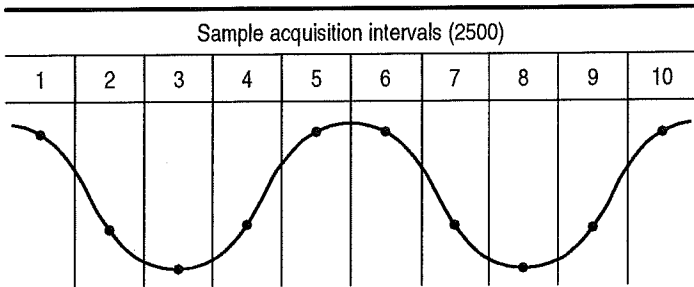

- Sample points

Sample mode acquires a single sample point in each interval.

The maximum sample rate is 1 GS/s. At a few SEC/DIV settings, this sample rate may not acquire 2,500 points. In this case a Digital Signal Processor generates points between the sampled points to make a full 2,500 points.

**Peak Detect.** Use Peak Detect acquisition mode to limit the possibility of aliasing. Also, use Peak Detect to detect glitches as narrow as 10 ns.

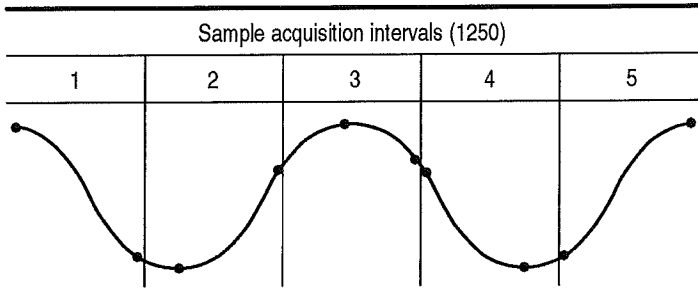

- Sample points displayed

Peak Detect mode displays highest and lowest acquired voltage in each interval.

Peak Detect functions at SEC/DIV settings of 5  $\mu\text{s}/\text{div}$  or slower. For SEC/DIV settings of 2.5  $\mu\text{s}/\text{div}$  or faster, the acquisition mode switches to Sample automatically.



**Average.** Use Average acquisition mode to reduce random or uncorrelated noise in the signal you want to display. Data is acquired in sample mode, then a number of waveforms are averaged together. Select the number of acquisitions (4, 16, 64, or 128) to average for the waveform.

**Scan Mode Display.** When the SEC/DIV control is set to 100 ms/div or slower and the trigger mode set to Auto, the instrument enters the scan acquisition mode. In this mode, the waveform display updates from left to right. There is no horizontal position or trigger control of waveforms during scan mode.

**Stopping the Acquisition.** While acquisition is running, the waveform display is live. Stopping the acquisition freezes the display. In either mode, the waveform display can be scaled or positioned with the vertical and horizontal controls.

## Autoset

The Autoset feature automatically adjusts the controls to produce a usable display of the input signal.

Pushing AUTOSET adjusts or sets each of the following items listed.

<b>Function</b>	<b>Setting</b>
Acquire mode	Sample
Vertical coupling	DC (if GND was selected)
Vertical VOLTS/DIV	Adjusted
Bandwidth	Full
Horizontal position	Centered
Horizontal SEC/DIV	Adjusted
Trigger type	Edge
Trigger source	Lowest numbered channel displayed
Trigger coupling	Adjusted to DC, Noise Reject, or HF Reject
Trigger slope	Rising
Trigger holdoff	Minimum
Trigger level	Set to 50%
Display format	YT
Trigger mode	Auto

## Cursors

Push the CURSOR button to display the measurement cursors and cursor menu.

Menu	Settings	Comments
Type	Voltage Time Off	Select and display the measurement cursors  Voltage measures amplitude and Time measures time and frequency
Source	CH1 CH2 MATH REFA REFB	Choose the waveform of the channel or source that the cursors are attached
Delta		The difference (delta) between the cursors is displayed here
Cursor 1		Displays cursor 1 location (time is referenced to the trigger position, voltage is referenced to ground)
Cursor 2		Displays cursor 2 location (time is referenced to the trigger position, voltage is referenced to ground)

### Key Points

**Cursor Movement.** Use the Vertical Position knobs to move cursors 1 and 2. You can move the cursors only while the Cursor menu is displayed.

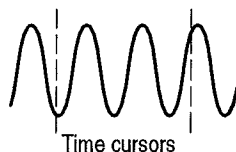
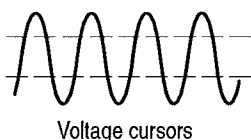

## Display

Push the DISPLAY button to choose how waveforms are presented and to change the appearance of the entire display.

Menu	Settings	Comments
Type	Vectors Dots	Vectors fills the space between adjacent sample points in the display  Dots displays only the sample points
Persist	OFF 1 sec 2 sec 5 sec Infinite	Sets the length of time each displayed sample point remains displayed
Format	YT XY	YT format displays the vertical voltage in relation to time (horizontal scale)  XY format displays channel 1 in the horizontal axis and channel 2 in the vertical axis
Contrast Increase		Darkens the black (or gray) areas of the display
Contrast Decrease		Lightens the white areas of the display

### Key Points

**Persistence.** When using persistence, old data retained is displayed in gray while the new data is black.

With Persistence set to Infinite, record points accumulate until a control is changed.

**XY Format.** Choose XY display format to display channel 1 in the horizontal axis and channel 2 in the vertical axis. Sample acquisition mode is used and the data is displayed as dots. The sampling rate is 1 ms/s.

The controls operate as follows:

- The channel 1 VOLTS/DIV and vertical POSITION controls set the horizontal scale and position.
- The channel 2 VOLTS/DIV and vertical POSITION controls continue to set vertical scale and position.

The following functions do not work in XY display format:

- Ref or Math waveforms
- Cursors
- Autoset (resets display format to YT)
- Timebase controls
- Trigger controls

## Hard Copy

Push the **HARDCOPY** button to print a hard copy of the display. The hard-copy function requires that an extension module with a Centronics, RS-232, or GPIB port be installed and connected to a printer.

Refer to the manual supplied with your extension module for instructions on connections and using the module.

Refer to *Optional Accessories* on page 54 for information about the available extension modules.

## Horizontal

You can use the horizontal controls to change the time base, horizontal position, and horizontal magnification of waveforms.

Menu	Settings	Comments
Main		The main horizontal timebase setting is used to display the waveform
Window Zone		Two cursors define a window zone Adjust the window zone with the Horizontal Position and SEC/DIV controls
Window		Changes the display to show the waveform segment (expanded to screen width) within the window zone
Trig knob	Level Holdoff	Selects whether the Trigger Level knob adjusts the trigger level (volts) or holdoff time (sec)  The holdoff value is displayed

### Key Points

**SEC/DIV.** If waveform acquisition is stopped (using the RUN/STOP button), the SEC/DIV control expands or compresses the waveform.

**Scan Mode Display.** When the SEC/DIV control is set to 100 ms/div or slower and the trigger mode set to Auto, the instrument enters the scan acquisition mode. In this mode, the waveform display updates from left to right. There is no trigger or horizontal control of waveforms during scan mode.

**Window Zone.** Use the window zone to expand a segment of a waveform to see more detail. The Window timebase setting cannot be set slower than the Main timebase setting.

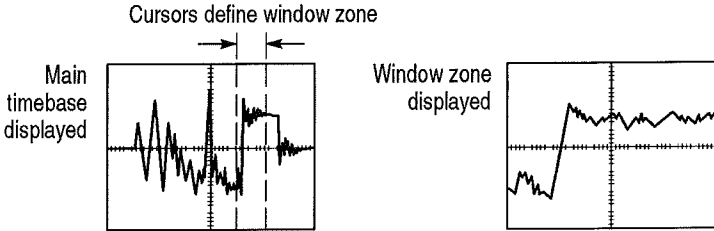

**Holdoff.** Use holdoff to help stabilize the display of nonperiodic waveforms.

Holdoff begins when the instrument recognizes a trigger event and disables the trigger system until acquisition is complete. The trigger system remains disabled during the holdoff time that follows each recognized trigger event.

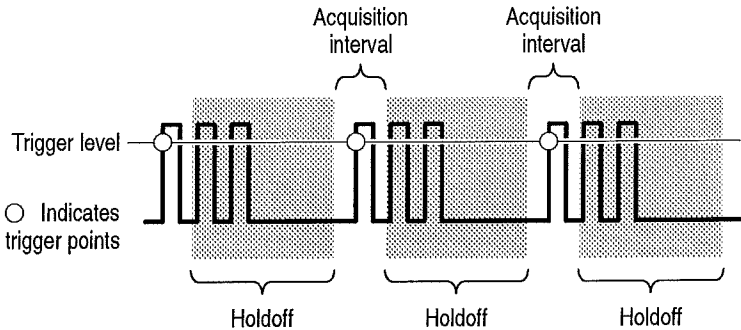

Triggers are not recognized during holdoff time.



## Math

Push the MATH MENU button to display the waveform math operations. Push the MATH MENU button again to turn off the math waveform display. Refer to page 42 for the vertical system descriptions.

Menu	Settings	Comments
CH1 – CH2		The channel 2 waveform is subtracted from the channel 1 waveform
CH2 – CH1		The channel 1 waveform is subtracted from the channel 2 waveform
CH1 + CH2		Channels 1 and 2 are added together
CH1 Inverted		The channel 1 signal display is inverted (cannot be inverted if channel 2 is inverted)
CH2 Inverted		The channel 2 signal display is inverted (cannot be inverted if channel 1 is inverted)

### Key Points

**VOLTS/DIV.** Use the VOLTS/DIV control to scale the channel 1 and channel 2 waveforms, thus scaling the math waveform.

**Channel Display.** Displaying a math waveform automatically removes the display of channels used to create the math waveform. Math operations are turned off if a channel used in the operation is turned on.

**Math Operations.** Only one math operation is allowed. Using the subtraction selection eliminates the need to first invert and then add the waveform for subtraction operations.

## Measure

Push the MEASURE button to access the automated measurement capabilities. There are five measurements available and the ability to display up to four at a time.

With Source highlighted, you define the channel you want the measurement to be performed on.

Menu	Settings	Comments
Source		With Source highlighted, choose the channel to measure
	CH1 CH2	Select a channel for the measurement  If the selected source (channel) is not displayed, CHx Off is displayed

With the Measure menu displayed and Type highlighted, you define the menu structure by selecting the type of measurement to display in each of the available menu locations.

Menu	Settings	Comments
Type		With Type highlighted, choose the type of measurement to display next to the on-screen-menu button
	Cyc RMS Mean Period Pk-Pk Freq None	Select the measurement type to display in each menu location  Select None to stop and remove measurements from the menu location

## Key Points

**Taking Measurements.** You can display up to four automated measurements at a time for a single waveform (or divided between the two waveforms). The waveform channel must be on (displayed) to make a measurement.

Automated measurements cannot be taken on reference or math waveforms or while using XY or scan mode.

Measurement Type	Definition
Cyc RMS	Provides a true RMS measurement of one complete cycle of the waveform
Mean	Provides the arithmetic mean voltage over the entire record
Period	Provides the time for one cycle
Pk-Pk	Provides the absolute difference between the maximum and minimum peaks of the entire waveform
Freq	Provides the frequency of the waveform

## Save/Recall

Push the **SAVE/RECALL** button to save or recall instrument setups or waveforms.

### Setups

Menu	Settings	Comments
Setups		Highlighting Setups displays the menus for storing or recalling instrument setups
Recall Factory		Sets the instrument controls to the predefined factory settings
Setup	1 2 3 4 5	Specifies the memory location to save the current instrument control settings
Save		Completes the save action
Recall		Recalls the instrument settings stored in the location chosen in the Setup field

### Key Points

**Saving and Recalling Setups.** The complete setup is stored in nonvolatile memory. When you recall the setup, you will be in the mode from which the setup was saved.

When turning the instrument on, all settings return to the settings that were in place when the instrument was turned off.

**Recalling the Factory Setup.** You can recall the Factory Setup to initialize the instrument to a known setup.

## Waveforms

Menu	Settings	Comments
Waveforms		Highlighting Waveforms displays the menus for storing or recalling waveforms
Source	CH1 CH2 Math	Choose the waveform display to store
Ref	A B	Choose the reference location to store or recall a waveform
Save		Stores source waveform to the chosen reference location
Ref(x)	ON OFF	Turns the reference waveform display on or off

**Saving and Recalling Waveforms.** You can store two reference waveforms in nonvolatile memory. These can be displayed simultaneously with current waveform acquisitions.

Recalled waveforms are not adjustable.

## Triggering

Two types of triggering are available: edge and video. A different set of menus is displayed for each trigger type.

### Edge Trigger

Use Edge triggering to trigger on the edge of the input signal at the trigger threshold.

Menu	Settings	Comments
Edge		With Edge highlighted, the rising or falling edge of the input signal is used for the trigger
Slope	Rising Falling	Select to trigger on either the rising or falling edge of the signal
Source	CH1 CH2 EXT EXT/5 AC Line	Select the input source as the trigger signal
Mode	Auto Normal Single	Select the type of triggering
Coupling	AC DC Noise Reject HF Reject LF Reject	Selects the components of the trigger signal applied to the trigger circuitry

## Key Points

**Normal and Auto Mode.** Use Normal trigger mode to trigger only on a valid trigger. Use Auto trigger mode to let the acquisition free-run in the absence of a valid trigger. Auto allows an untriggered, scanning waveform at 100 ms/div or slower time base settings.

**Single Mode.** Use Single trigger mode to capture a single acquisition of an event. The content of a single acquisition sequence depends on the acquisition mode.

Acquisition Mode	Single Acquisition Sequence
Sample or Peak Detect	Sequence is complete when one acquisition is acquired
Average	Sequence is complete when the defined number of acquisitions is reached (refer to page 20)

**AC Line Source.** The AC Line trigger source uses the power signal as the trigger source. Trigger coupling is set to DC and the trigger level to 0 volts.

**Coupling.** Coupling allows you to filter the trigger signal used to trigger an acquisition.

- AC blocks the DC component.
- DC passes all components of the signal.
- Noise Reject passes all components of the signal but increases the peak-to-peak signal required.
- HF Reject attenuates the high-frequency components above 80 kHz.
- LF Reject blocks the DC component and attenuates the low-frequency components below 30 kHz.

**Pretrigger.** The trigger position is typically set at the horizontal center of the screen. In this case you are able to view five divisions of pretrigger information. Adjusting the Horizontal Position of the waveform allows you to see more or less pretrigger information.

**Trigger View.** Pushing TRIGGER VIEW displays the trigger waveform until the button is released.

When displaying the trigger acquisition, all front-panel buttons are disabled except **HARDCOPY**.



## Video Trigger

Choose video triggering to trigger on fields or the lines of an NTSC, PAL, or SECAM standard video signal.

Menu	Settings	Comments
Video		With Video highlighted, triggering occurs on an NTSC, PAL, or SECAM standard video signal  Trigger coupling is preset to AC
Polarity	Normal Inverted	Normal triggers on the negative edge of the sync pulse and Inverted triggers on the positive edge of the sync pulse
Source	CH1 CH2 EXT EXT/5	Selects the input source as the trigger signal  EXT and EXT/5 uses the signal applied to the EXT TRIG connector as the source
Sync	Field Line	Select to trigger on fields or lines

## Key Points

**Sync Pulses.** When you choose Normal Polarity, the trigger always occurs on negative-going sync pulses. If your video signal has positive-going sync pulses, use the Inverted Polarity selection.

## Utility

Push the **UTILITY** button to display the utility menus. The Utility menus change with the addition of extension modules. The menus explained here relate to the product without any module installed. Refer to the manual supplied with your extension module for items not discussed here.

Menu	Settings	Comments
System Status		Displays the system menus
Do Self Cal		Performs a self calibration
Error Log		Displays a list of any errors logged This list is useful when contacting a Tektronix Service Center for help
Language	English French German Italian Spanish Portuguese Japanese Korean Simplified Chinese Traditional Chinese	Selects the display language of the operating system

### Key Points

**Self Calibration.** The self calibration routine optimizes the oscilloscope accuracy for the ambient temperature. For maximum accuracy, perform a self cal if the ambient temperature changes by 5° C or more.

To compensate the signal path, disconnect any probes or cables from the channel 1 and channel 2 input connectors. Then, select Do Self Cal to confirm that you are ready to proceed.

### System Status

Selecting System Status from the utility menu displays the menus available for obtaining a list of control settings for each group of instrument controls.

Push any front-panel menu button to remove the status screen.

Menu	Settings	Comments
Horizontal		Lists parameters of the horizontal system
Vertical		Lists vertical parameters for channels 1 and 2 plus any reference waveforms
Trigger		Lists parameters of the trigger system
Misc		Lists the model of the instrument and extension module, software version, and GPIB and RS-232 information

## Vertical

You can use the vertical controls to display waveforms, adjust vertical scale and position, and set input parameters. Refer to page 31 for the vertical math descriptions.

### Channel 1 or Channel 2 Vertical Menu

The vertical menu contains the following items for channel 1 or channel 2. Each item is set individually for each channel.

Menu	Settings	Comments
Coupling	DC AC GND	DC passes both AC and DC components of the input signal  AC blocks the DC component of the input signal  GND disconnects the input signal
BW Limit	20 MHz Off	Limits the bandwidth to reduce display noise
Volts/Div	Coarse Fine	Selects the resolution of the Volts/Div knob  Coarse defines a 1–2–5 sequence. Fine changes the resolution to small steps between the coarse settings
Probe	1x 10x 100x 1000x	Set this to match your probe attenuation factor to make the vertical scale readout correct

### Key Points

**GND Coupling.** Use GND coupling to display a zero-volt waveform. When you use GND coupling, the input BNC connector is disconnected from internal circuits. Internally, the channel input is connected to a zero-volt reference level.

**Fine Resolution.** The vertical scale readout displays the actual Volts/Div setting while in the fine resolution setting. Changing the setting to coarse does not change the vertical scale until the VOLTS/DIV control is adjusted.

**Waveform off.** To remove a waveform from the display, push the CH 1 MENU or CH 2 MENU button to display its vertical menu. Push the menu button again to turn the waveform off. An input channel can still be used as a trigger source or for math displays while turned off.

# Appendix A: Specifications

All specifications apply to the TDS 210 and TDS 220 with a P6112 probe unless noted otherwise. To meet specifications, two conditions must first be met:

- The instrument must have been operating continuously for ten minutes within the specified operating temperature.
- You must perform the Self Cal operation, accessible through the utility menu, if the operating temperature changes by more than 5° C.

All specifications are guaranteed unless noted “typical.”

## Specifications

Acquisition		
Acquisition Modes	Sample, Peak detect, and Average	
Acquisition Rate, typical	Up to 180 waveforms per second (2 channels, sample acquisition mode, no measurements)	
Single Sequence	<i>Acquisition Mode</i>	<i>Acquisition Stops After</i>
	Sample, Peak Detect	Single acquisition, one or two channels simultaneously
	Average	N acquisitions, one or two channels simultaneously, N is selectable from 4, 16, 64, and 128

**Specifications (Cont.)**

<b>Inputs</b>		
Input Coupling	DC, AC, or GND	
Input Impedance, DC Coupled	1 M $\Omega$ $\pm$ 2% in parallel with 20 pF $\pm$ 3 pF	
P6112 Probe Attenuation	10X	
Maximum Voltage Between Signal and Common at input BNC	<i>Overvoltage Category</i>	<i>Maximum Voltage</i>
	CAT I and CAT II	300 V <sub>RMS</sub>
	For steady-state sinusoidal waveforms, derate at 20 dB/decade above 100 kHz to 13 V <sub>pk</sub> at 3 MHz and above. Also, refer to Overvoltage Category description on page 53.	
Maximum Voltage Between Probe Tip and ground using P6112 connected to input BNC	<i>Overvoltage Category</i>	<i>Maximum Voltage</i>
	CAT I and CAT II	300 V <sub>RMS</sub>
	Derate at 20 dB/decade above 900 kHz to 13 V <sub>RMS</sub> at 27 MHz and above. Also, refer to Overvoltage Category description on page 53.	
Channel-to-Channel Common Mode Rejection, typical	<i>TDS 210</i>	<i>TDS 220</i>
	100:1 at 60 Hz 20:1 at 30 MHz	100:1 at 60 Hz 20:1 at 50 MHz
	Measured on MATH Ch1 – Ch2 waveform, with test signal applied between signal and common of both channels, and with the same VOLTS/DIV and coupling settings on each channel.	
Channel-to-Channel Crosstalk	<i>TDS 210</i>	<i>TDS 220</i>
	$\geq$ 100:1 at 30 MHz	$\geq$ 100:1 at 50 MHz
	Measured on one channel, with test signal applied between signal and common of the other channel, and with the same VOLTS/DIV and coupling settings on each channel.	

## Specifications (Cont.)

Vertical		
Digitizers	8 bit resolution, each channel sampled simultaneously	
VOLTS/DIV Range	2 mV/div to 5 V/div at input BNC (Full bandwidth at > 5 mV/div to 5 V/div, 20 MHz at 2 mV/div to 5 mV/div)	
Position Range	2 mV/div to 200 mV/div, $\pm 2$ V > 200 mV/div to 5 V/div, $\pm 50$ V	
Analog Bandwidth at BNC or with P6112, probe DC Coupled	<i>TDS 210</i>	<i>TDS 220</i>
	60 MHz	100 MHz
Peak Detect Bandwidth, typical	<i>TDS 210</i>	<i>TDS 220</i>
	50 MHz (5 s/div to 5 $\mu$ s/div) (20 MHz at 2 mV/div to 10 mV/div)	75 MHz (5 s/div to 5 $\mu$ s/div) (20 MHz at 2 mV/div to 10 mV/div)
Analog Bandwidth Limit, typical	Selectable between 20 MHz or full	
Lower Frequency Limit, AC Coupled	$\leq 10$ Hz at BNC	
	$\leq 1$ Hz when using a 10X passive probe	
Rise Time at BNC, typical	<i>TDS 210</i>	<i>TDS 220</i>
	<5.8 ns	<3.5 ns
Peak Detect Response	Captures 50% or greater amplitude of pulses $\geq 10$ ns wide (5 s/div to 5 $\mu$ s/div)	
DC Gain Accuracy	$\pm 3\%$ for Sample or Average acquisition mode	



## Specifications (Cont.)

<b>Vertical</b>		
	<i>Measurement Type</i>	<i>Accuracy</i>
DC Measurement Accuracy, Average Acquisition Mode	Average of $\geq 16$ waveforms with vertical position at zero	$\pm(3\% \times \text{reading} + 0.1 \text{ div} + 1 \text{ mV})$
	Average of $\geq 16$ waveforms with vertical position not at zero	$\pm[3\% \times (\text{reading} + \text{vertical position}) + 1\% \text{ of vertical position} + 0.2 \text{ div}]$  Add 2 mV for settings from 2 mV/div to 200 mV/div. Add 50 mV for settings from $>200 \text{ mV/div}$ to 5 V/div.
	Delta Volts Measurement Accuracy, Average Acquisition Mode	Delta volts between any two averages of $\geq 16$ waveforms acquired under same setup and ambient conditions
<b>Horizontal</b>		
Sample Rate Range	50 S/s to 1 GS/s	
Record Length	2500 samples for each channel	
SEC/DIV Range	5 ns/div to 5 s/div, in a 1, 2.5, 5 sequence	
Sample Rate and Delay Time Accuracy	$\pm 100 \text{ ppm}$ over any $\geq 1 \text{ ms}$ time interval	
Delta Time Measurement Accuracy (Full Bandwidth)	<i>Conditions</i>	<i>Accuracy</i>
	Single-shot, sample mode	$\pm(1 \text{ sample interval} + 100 \text{ ppm} \times \text{reading} + 0.6 \text{ ns})$
	$> 16$ averages	$\pm(1 \text{ sample interval} + 100 \text{ ppm} \times \text{reading} + 0.4 \text{ ns})$
	Sample interval = $s/\text{div} \div 250$	
Position Range	5 ns/div to 10 ns/div	$(-4 \text{ div} \times s/\text{div})$ to 20 ms
	25 ns/div to 100 $\mu\text{s}/\text{div}$	$(-4 \text{ div} \times s/\text{div})$ to 50 ms
	250 $\mu\text{s}/\text{div}$ to 5 s/div	$(-4 \text{ div} \times s/\text{div})$ to 50 s

## Specifications (Cont.)

<b>Trigger</b>			
Trigger Sensitivity, Edge Trigger Type	<i>Coupling</i>	<i>Sensitivity</i>	
	DC	<i>CH 1 and CH 2</i>	1 div from DC to 10 MHz, 1.5 div from 10 MHz to Full
		<i>EXT</i>	100 mV from DC to 10 MHz, 150 mV from 10 MHz to Full
		<i>EXT/5</i>	500 mV from DC to 10 MHz, 750 mV from 10 MHz to Full
Trigger Sensitivity, Edge Trigger Type, typical	<i>Coupling</i>	<i>Sensitivity</i>	
	NOISE REJ	Reduces the DC-coupled trigger sensitivity by 2 times for > 10 mv/div to 5 V/div	
	HF REJ	Same as the DC-coupled limit from DC to 7 kHz, attenuates signals above 80 kHz	
	LF REJ	Same as the DC-coupled limits for frequencies above 300 kHz, attenuates signals below 300 kHz	
Trigger Level Range	<i>Source</i>	<i>Range</i>	
	Internal	$\pm 8$ divisions from center of screen	
	EXT	$\pm 1.6$ V	
	EXT/5	$\pm 8$ V	
Trigger Level Accuracy, typical	Accuracies are for signals having rise and fall times $\geq 20$ ns		
	<i>Source</i>	<i>Accuracy</i>	
	Internal	$\pm 0.2$ div $\times$ volts/div within $\pm 4$ divisions from center screen	
	EXT	$\pm (6\% \text{ of setting} + 40 \text{ mV})$	
	EXT/5	$\pm (6\% \text{ of setting} + 200 \text{ mV})$	

**Specifications (Cont.)**

<b>Trigger</b>		
SET LEVEL TO 50%, typical	Operates with input signals $\geq 50$ Hz	
Sensitivity, Video Trigger Type, typical	Composite video signal	
	<i>Source</i>	<i>Range</i>
	Internal	Pk-pk amplitude of 2 divisions
	EXT	400 mV
	EXT/5	2 V
Signal Formats and Field Rates, Video Trigger Type	Supports NTSC, PAL, and SECAM broadcast systems for any field or any line	
Holdoff Range	500 ns to 10 s	
<b>Measurements</b>		
Cursors	Voltage difference between cursors ( $\Delta V$ )	
	Time difference between cursors ( $\Delta T$ )	
	Reciprocal of $\Delta T$ in Hertz ( $1/\Delta T$ )	
Automated Measurements	Cycle RMS, Mean, Pk – Pk, Period, Frequency	

**General Specifications**

<b>Display</b>		
Display Type	5.7 in. (145 mm) diagonal liquid crystal	
Display Resolution	320 horizontal by 240 vertical pixels	
Display Contrast	Adjustable, temperature compensated	
Backlight Intensity, typical	35 cd/m <sup>2</sup>	
<b>Probe Compensator Output</b>		
Output Voltage, typical	5 V into $\geq 1 \text{ M}\Omega$ load	
Frequency, typical	1 kHz	
<b>Power Source</b>		
Source Voltage	90 – 250 VAC <sub>RMS</sub> from 45 through 440 Hz, CAT II	
Power Consumption	Less than 20 W	
Fuse	1 A, T rating, 250 V	
<b>Environmental</b>		
Temperature	Operating	0° C to +50° C
	Nonoperating	-20° C to +60° C
Cooling Method	Convection	
Humidity	+40° C or below	≤90% relative humidity
	+41° C to +50° C	≤60% relative humidity
Altitude	Operating	2,000 m
	Nonoperating	15,000 m

**General Specifications (Cont.)**

<b>Environmental</b>		
Random Vibration	Operating	0.31 g <sub>RMS</sub> from 5 Hz to 500 Hz, 10 minutes on each axis
	Nonoperating	2.46 g <sub>RMS</sub> from 5 Hz to 500 Hz, 10 minutes on each axis
<b>Mechanical</b>		
Size	Height	151.4 mm (5.96 in.)
	Width	304.8 mm (12 in.)
	Depth	120.7 mm (4.75 in.)
Weight (approximate)	When packaged for domestic shipment	3.06 kg (6.75 lbs)

**General Specifications (Cont.)**

<b>Certifications and Compliances</b>	
EC Declaration of Conformity  (TDS 210, TDS 220)	Meets intent of Directive 89/336/EEC for Electromagnetic Compatibility and Low-Voltage Directive 73/23/ECC as amended by 93/68/EEC for Product Safety. Compliance was demonstrated to the following specifications as listed in the Official Journal of the European Communities:  EN 50081-1 Emissions: EN 55011 Class A Radiated and Conducted Emissions EN 60555-2 AC Power Line Harmonic Emissions  EN 50082-1 Immunity: IEC 801-2 Electrostatic Discharge Immunity IEC 801-3 RF Electromagnetic Field Immunity IEC 801-4 Electrical Fast Transient/Burst Immunity IEC 801-5 Power Line Surge Immunity
(TDS 210, TDS 220, P6112)	Low Voltage Directive 73/23/EEC as amended by 93/68/EEC: EN 61010-1/A2:1995 Safety requirements for electrical equipment for measurement, control, and laboratory use
(P6112)	EN 61010-2-031:1994 Particular requirements for hand-held probe assemblies for electrical measurement and test
Certifications (TDS 210, TDS 220, P6112)  (P6112)	CAN/CSA C22.2 No. 1010.1-92 UL3111-1, First Edition  IEC61010-1/A2 IEC61010-2-031
CSA Certified Power Cords	CSA Certification includes the products and power cords appropriate for use in the North America power network. All other power cords supplied are approved for the country of use.
Pollution Degree 2	Do not operate in environments where conductive pollutants may be present.

**General Specifications (Cont.)****Certifications and Compliances**

Overvoltage Category	Category:	Examples of Products in this Category:
	CAT III	Distribution-level mains, fixed installation
	CAT II	Local-level mains, appliances, portable equipment
	CAT I	Signal levels in special equipment or parts of equipment, telecommunications, electronics

**Adjustment Interval**

The recommended calibration interval is one year

---

## Appendix B: Accessories

All accessories (standard and optional) are available by contacting your local Tektronix field office.

### Standard Accessories



**P6112 10X Passive Probes.** The P6112 10X passive probes have a 100 MHz bandwidth and a rating of 300 V CAT II.

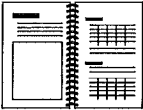

**TDS 210 & TDS 220 User Manual.** A single User Manual is included. Refer to the Optional Accessories for a complete list of available language manuals.

---

### Optional Accessories

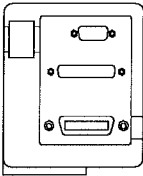

**TDS2MM Measurement Extension Module.** The TDS2MM module plugs directly into the rear panel of any TDS 200 Series oscilloscope. This module provides full GPIB and RS-232 compatibility and a Centronics port for hard copy output. PC compatible software is included. The module allows measurement of rise time, fall time, and positive and negative pulse width. The module also provides Fast Fourier Transform (FFT).

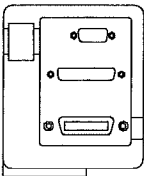

**TDS2CM Communications Extension Module.** The TDS2CM Communications module plugs directly into the rear panel of any TDS 200 Series oscilloscope. This module provides full GPIB and RS-232 compatibility and a Centronics port for hard copy output. PC compatible software is included.

---



**Optional Accessories (Cont.)**

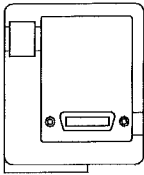

**TDS2HM Hard Copy Extension Module.** The TDS2HM module plugs directly into the rear panel of any TDS 200 Series oscilloscope. This module provides a Centronics port for hard copy output.

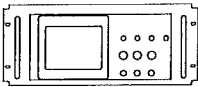

**RM200 Rackmount Kit.** The RM200 Rackmount Kit lets you install a TDS 200-Series oscilloscope into an industry-standard 19 inch rack. The rackmount kit requires seven inches of vertical rack space. You can turn the oscilloscope power on or off from the front of the rackmount kit. The rackmount kit does not have slide-out capability.

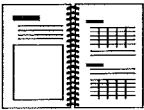

**TDS 210 & TDS 220 Service Manual.** The service manual (070-9693-XX, English) provides module level repair information.

**TDS 210 & TDS 220 User Manuals.** The User manual is available in these languages:

English	070-8483-XX
French	070-8520-XX*
German	070-8484-XX*
Italian	070-8980-XX*
Spanish	070-9560-XX*
Portuguese	070-9561-XX*
Japanese	070-9562-XX
Korean	070-9564-XX
Simplified Chinese	070-9563-XX
Traditional Chinese	070-9568-XX

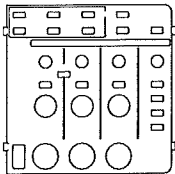

\*These manuals contain a language overlay for the front-panel controls.

**Optional Accessories (Cont.)**

---

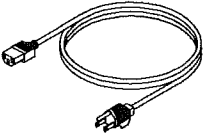

**International Power Cords.** In addition to the power cord shipped with your instrument, you can obtain the following cords:

North American	110 V 60 Hz
North American	240 V, 50 Hz
Universal European	220 V, 50 Hz
UK	240 V, 50 Hz
Switzerland	220 V, 50 Hz

---

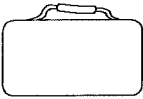

**Soft Case.** The soft case (AC220) protects the instrument from damage and provides space for probes, power cord, and manuals.

---

# Appendix C: General Care and Cleaning

## General Care

Do not store or leave the instrument where the LCD display will be exposed to direct sunlight for long periods of time.



---

**CAUTION.** *To avoid damage to the instrument or probes, do not expose them to sprays, liquids, or solvents.*

---

## Cleaning

Inspect the instrument and probes as often as operating conditions require. To clean the exterior surface, perform the following steps:

1. Remove loose dust on the outside of the instrument and probes with a lint-free cloth. Use care to avoid scratching the clear plastic display filter.
2. Use a soft cloth dampened with water to clean the instrument. Use an aqueous solution of 75% isopropyl alcohol for more efficient cleaning.



---

**CAUTION.** *To avoid damage to the surface of the instrument or probes, do not use any abrasive or chemical cleaning agents.*

---



# Glossary

## **AC Coupling**

A mode that blocks the DC component of a signal but passes the dynamic (AC) component of the signal. Useful for observing an AC signal that is normally riding on a DC signal.

## **Acquisition**

The process of sampling signals from input channels, digitizing the samples, processing the results into data points, and assembling the data points into a waveform record. The waveform record is stored in memory.

## **Aliasing**

A false representation of a signal due to insufficient sampling of high frequencies or fast transitions. A condition that occurs when an oscilloscope digitizes at an effective sampling rate that is too slow to reproduce the input signal. The waveform displayed on the oscilloscope may have a lower frequency than the actual input signal.

## **Attenuation**

The degree the amplitude of a signal is reduced when it passes through an attenuating device such as a probe or attenuator (the ratio of the input measure to the output measure). For example, a 10X probe attenuates, or reduces, the input voltage of a signal by a factor of 10.

## **Auto Trigger Mode**

A trigger mode that causes the oscilloscope to automatically acquire if it does not detect a triggerable event.

## **Average Acquisition Mode**

A mode in which the oscilloscope acquires and displays a waveform that is the averaged result of several acquisitions. This reduces the apparent noise. The oscilloscope acquires data as in the sample mode and then averages it according to a specified number of averages.

**Backlight**

The illumination behind the liquid-crystal display.

**Bezel Buttons**

The row of buttons beside the display that selects items in the menus.

**Cursors**

Paired markers that you can use to make measurements between two waveform locations. The oscilloscope displays the values (expressed in volts or time) of the position of each cursor and the distance between the two cursors.

**DC Coupling**

A mode that passes both AC and DC signal components to the circuit. Available for both the trigger system and the vertical system.

**Digital Real Time Digitizing**

A digitizing technique that samples the input signal with a sample frequency of at least four times the oscilloscope bandwidth. (The TDS 210 and TDS 220 samples at least 10 times the bandwidth.) Combined with  $(\sin x)/x$  interpolation, all frequency components of the input up to the bandwidth are accurately displayed.

**Digitizing**

The process of converting a continuous analog signal such as a waveform to a set of discrete numbers representing the amplitude of the signal at specific points in time.

**Display**

The word used to refer to the screen or the LCD (liquid crystal display).

**Edge Trigger**

Triggering that occurs when the oscilloscope detects the source passing through a specified voltage level in a specified direction (the trigger slope).

**Ground (GND) Coupling**

Coupling option that disconnects the input signal from the vertical system.

**Ground Lead**

The reference lead for an oscilloscope.

**Hard Copy**

An electronic copy of the display in a format useable by a printer.

**Holdoff**

A specified amount of time that must elapse after a trigger signal before the trigger circuit will accept another trigger signal. Holdoff helps ensure a stable display.

**Voltage Cursors**

The two horizontal bars that you position to measure the voltage parameters of a waveform. The oscilloscope displays the value of each cursor with respect to ground and the voltage value between the bars.

**Menu**

A set of labels shown in the display to identify the functions of the bezel buttons. The specific menu contents depend on the menu button you press.

**Normal Trigger Mode**

A mode where the oscilloscope does not acquire a waveform record unless a valid trigger event occurs. It waits for a valid trigger event before acquiring waveform data.

**Peak Detect Mode**

A mode in which the oscilloscope creates a pair of record points during each sample interval. Each pair consists of the maximum and minimum input voltage during the interval.

**Persistence**

A method of retaining old data on the display for a period of time.

**Pixel**

A visible point on the display. The display is 320 pixels wide by 240 pixels high.

**Pretrigger**

The specified portion of the waveform record that contains data acquired before the trigger event.

**Record Length**

The specified number of samples in a waveform.

**Reference Waveform**

A saved waveform selected for display. You can display two reference waveforms as Wfm A and Wfm B.

**RS-232**

The serial communication port used to connect to a hard-copy device, computer, controller, or terminal.

**Sample Acquisition Mode**

A mode in which the oscilloscope creates a record point by saving a sample during each acquisition interval.

**Sample Interval**

The time interval between successive samples in a time base. For real-time digitizers, the sample interval is the reciprocal of the sample rate.

**Sampling**

The process of capturing an analog input, such as a voltage, at a discrete point in time and holding it constant so that it can be quantized.

**Scan Mode**

An acquisition mode useful at slow horizontal scale settings. Scan mode allows you to view the waveform as it is acquired point-by-point. The waveform appears from left to right across the display.

**Time Base**

The set of parameters that let you define the time and horizontal

axis attributes of a waveform record. The time base determines when and how long to acquire record points.

**Time Cursors**

The two vertical bars you position to measure the time parameter of a waveform record. The oscilloscope displays the value of each cursor with respect to trigger and the time value between the bars.

**Video Trigger**

Triggering on the sync pulse of a composite video signal.

**XY Format**

A display format that compares the voltage level of two waveform records point by point. It is useful for studying phase relationships between two waveforms.

**YT Format**

The conventional oscilloscope display format. It shows the voltage of a waveform record (on the vertical axis) as it varies over time (on the horizontal axis).



# Index

## A

- AC line, trigger source, 37
- accessories, 54–56
- acquire, menu, 20
- ACQUIRE button, 17, 20
- acquisition
  - live display, 23
  - modes, 20
  - stopping, 23
- attenuation, probe, 42
- auto trigger, 37
- AUTOSET, actions, 24
- AUTOSET button, 17, 24
- average, 20, 23

## B

- bandwidth, limit, 42
- broken waveforms, 12
- buttons, trigger view, 16, 38

## C

- calibration, 40
- Centronics, 2, 54
- CH 1 connector, 18
- CH 1 MENU button, 14
- CH 2 connector, 18
- CH 2 MENU button, 14
- channel, scale, 11
- cleaning, 57
- coarse resolution, 42
- compensation
  - probe, 6, 18
  - signal path, 40

- connectors, 18
  - ch1, 18
  - ch2, 18
  - ext trig, 18
  - probe comp, 18
- contrast, 26
- coupling
  - trigger, 36, 38
  - vertical, 42
- cursor
  - adjusting, 17
  - menu, 25
  - using, 25
- CURSOR button, 17, 25

## D

- description, general, 1
- display, 10
  - contrast, 26
  - format, 26
  - indicators, 10
  - intensity, 26
  - menu, 26
  - persistence, 26
  - type, 26
- DISPLAY button, 17, 26
- dots, 26
- dual timebase, 15, 29

## E

- error log, 40
- EXT TRIG connector, 18
- extension, module, 2, 54
- external trigger, 18

## F

- factory setup, recalling, 34
- features, overview, 1
- fine resolution, 42
- FORCE TRIGGER button, 16
- format, 26
- functional check, 5

## G

- GPIB, 2, 54
- graticule, 26
- gray waveforms, 12
- ground, marker, 11
- ground terminal, probe, 7

## H

- HARDCOPY button, 17, 28
- HOLDOFF, control, 16
- holdoff, 16, 30
- horizontal
  - menu, 29
  - position marker, 11
  - status, 41
- HORIZONTAL MENU button, 15

## I

- intensity, 26
- invert, 31

## L

- languages, 40
- LEVEL, control, 16

## M

- main timebase, 15, 29
- manuals, 55
- math
  - functions, 31
  - menu, 31
- MATH MENU button, 14
- measure, menu, 32
- MEASURE button, 17
- measurements
  - automatic, 32
  - frequency, 33
  - mean, 33
  - peak-to-peak, 33
  - period, 33
  - RMS, 33
  - types, 33
- menus
  - acquire, 20
  - cursor, 25
  - display, 26
  - horizontal, 29
  - math, 31
  - measure, 32
  - save/recall, 34
  - trigger, 36
  - utility, 40
  - vertical, 42
- messages, 11

## N

- normal trigger, 37
- NTSC, 39

**P**

PAL, 39  
peak detect, 20, 22  
persistence, 26, 27  
ports, 2  
position, vertical, 42  
POSITION control  
  cursors, 14  
  horizontal, 15  
  vertical, 14  
power, 3  
power cords, 3, 56  
pretrigger view, 38  
printing, 28  
PROBE COMP connector, 18  
probes  
  attenuation, 42  
  compensation, 6, 18  
  safety, 7  
  specifications, 44

**R**

resolution, fine, 43  
roll mode, 29  
RS-232, 2, 54  
  hard copy, 28  
RUN/STOP button, 17

**S**

sample, 20, 21  
SAVE/RECALL button, 17, 34  
saving  
  setups, 34  
  waveforms, 35  
scan mode, 23  
scanning waveform, 23, 29, 37  
SEC/DIV control, 15, 29

SECAM, 39  
security, 3  
self cal, 40  
service, 40, 55  
SET LEVEL TO 50% button, 16  
setups, saving and recalling, 34  
signal path compensation, 40  
single acquisition, 37  
source, trigger, 36, 39  
specifications, 44  
status, system, 40  
sync pulse, 39

**T**

time cursors, 25  
timebase, 11  
  main, 15, 29  
  window, 15, 29  
trigger  
  auto, 37  
  coupling, 36, 38  
  edge, 36  
  external, 39  
  field, 39  
  holdoff, 16, 30  
  level, 16, 30, 36  
  menu, 36  
  normal, 37  
  position marker, 11  
  single, 37  
  slope, 36  
  source, 36  
  status, 11, 41  
  sync, 39  
  video, 39  
  view, 16, 39  
trigger level  
  marker, 11  
  readout, 11

TRIGGER MENU button, 16  
trigger position, readout, 11  
trigger slope, indicator, 11  
trigger source, 11  
trigger view, 38, 39  
TRIGGER VIEW button, 16

## U

utility, menu, 40  
UTILITY button, 17

## V

vectors, 26  
vertical  
  menu, 42  
  status, 41  
voltage cursors, 25  
volts/div  
  coarse, 42  
  fine, 42  
  math, 31

VOLTS/DIV control, 14

## W

waveform  
  appearance, 12  
  compression, 29  
  displays, 12  
  expansion, 29  
  off, 43  
waveforms, saving and recalling,  
  34  
window timebase, 15, 29  
window zone, 11, 30

## X

XY, 26  
XY display, 27

## Y

YT, 26